

# BOITE DE BRANCHEMENT CYLINDRIQUE

## SERIE TP Ø60 H : 50 Ep 8

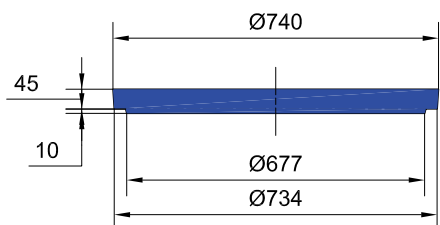

**COUVERCLE Ep 5,5 cm  
POUR BOITE DE BRANCHEMENT CYL Ø60**

**Code Article :** 430575  
**Poids :** 58 Kg

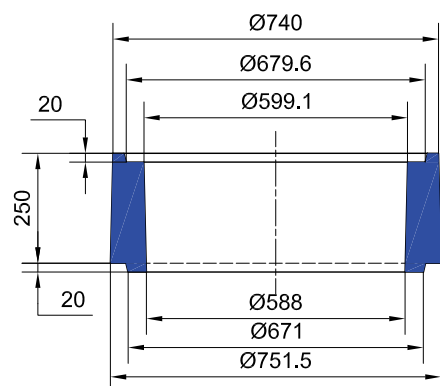
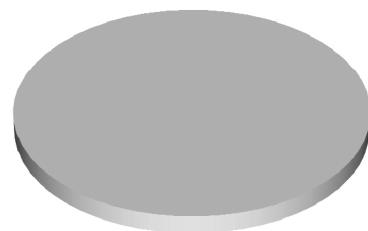

**REHAUSSE H : 25 POUR BOITE DE  
BRANCHEMENT Ø60 CYLINDRIQUE**

**Code Article :** 430565  
**Poids :** 98 Kg

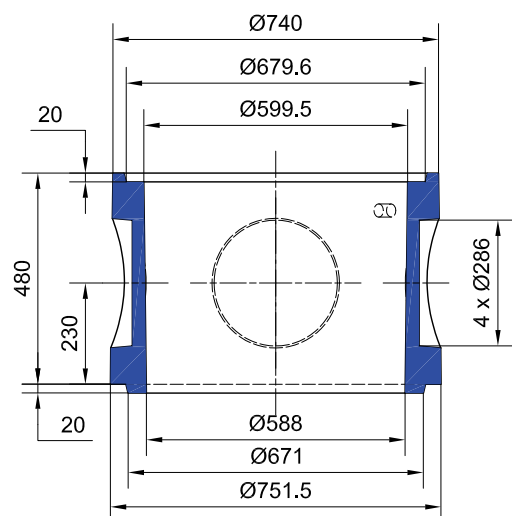
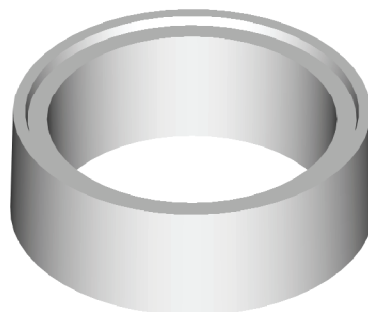

**REHAUSSE H : 50 POUR BOITE DE  
BRANCHEMENT Ø60 CYLINDRIQUE**

**Code Article :** 430570  
**Poids :** 144 Kg

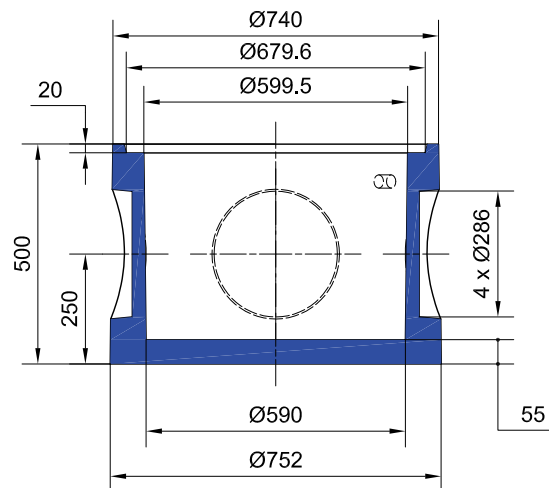
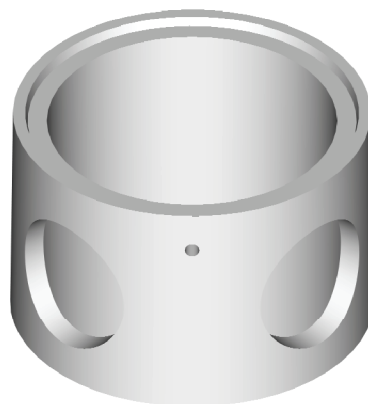

**BOITE DE BRANCHEMENT  
CYLINDRIQUE TP Ø60 H : 50 Ep. 8  
SANS COUVERCLE**

**Code Article :** 430560  
**Poids :** 187 Kg

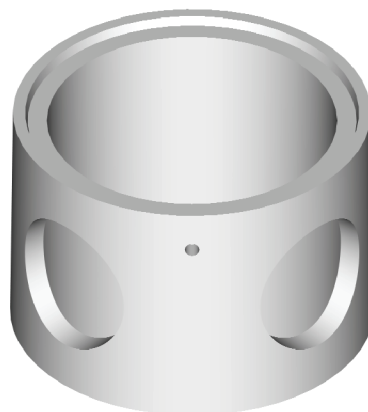

**S.A. R.THEBAULT**

Siège social et usine : ZI de Saint-Eloi - Plouédern - 29800 LANDERNEAU

Tél. 02 98 21 63 63 - Fax : 02 98 21 34 11

Usines à : Mauron (56430) et Verneuil S/Avre (27130)