

# FICHE PRODUIT

## SEUIL PMR R345 REXLAN L160 à L190

Code: **543949**    Groupe article: **3A 326 A11**  
 Dessiné le: **15/12/09**    Par: **M.L.D**  
 Version du: **28/01/11**    Version: **1**  
 Référence à la norme: **NF P 98-052 (appuis)**

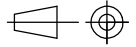

Utilisation: **Seuil accessibilité handicapé isolation 100/120** Tolérance générale  $\pm 0,5$  sauf indications    Poids: **var.**

LONGEUR	L	B	Poids	
1,70m	174	152	33,0 kg	<input checked="" type="checkbox"/>

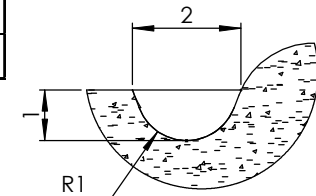

**DÉTAIL B**  
**PROFIL DE LA RIGOLE**

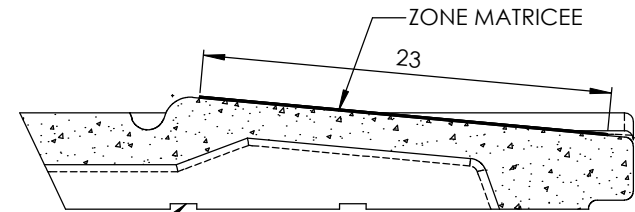
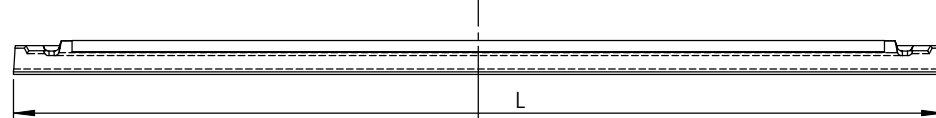
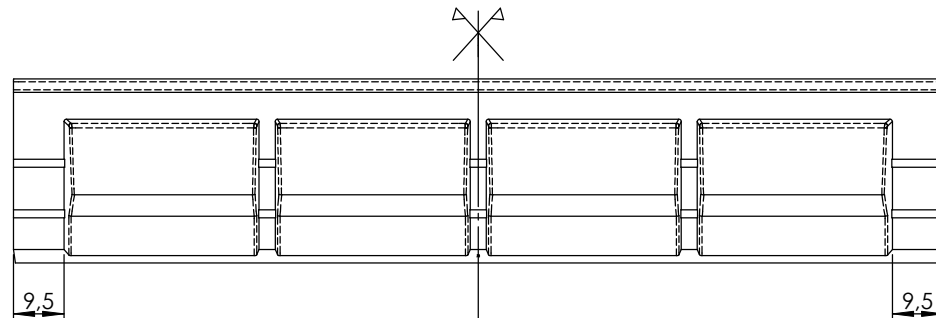

Réservations 15x3

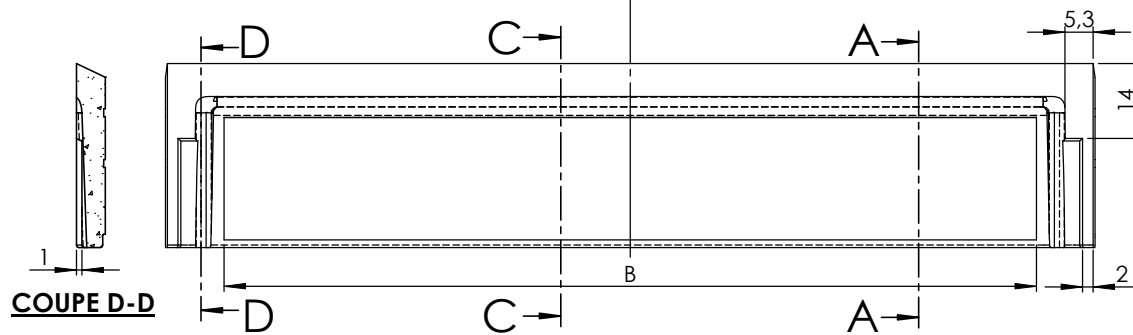

**COUPE D-D**

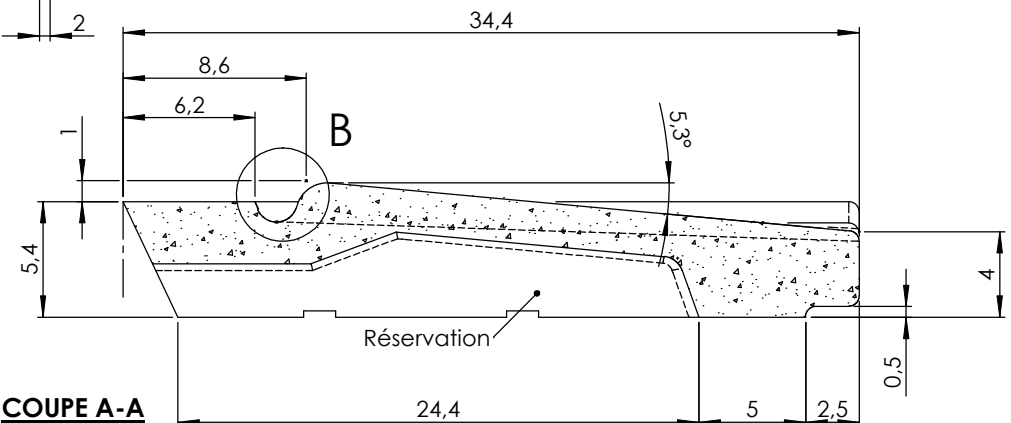

**COUPE A-A**

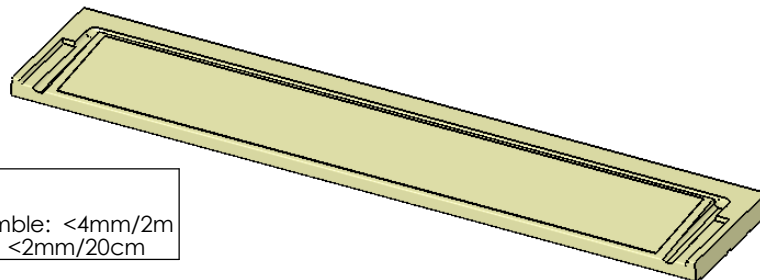

**TOLERANCES:**

Planéité d'ensemble: <4mm/2m  
 Bosse et flache: <2mm/20cm