

DÉCLARATION DES PERFORMANCES

DoP 0192

pour goujon d'ancrage fischer FBN II, FBN II R (fixation mécanique pour utilisation dans le béton)

FR

1. <u>Code d'identification unique du type de produit:</u>	DoP 0192		
2. <u>Usage(s) prévu(s):</u>	Fixation dans du béton non fissuré.		
3. <u>Fabricant:</u>	Voir annexes, en particulier les annexes B1- B3 fischerwerke GmbH & Co. KG, Klaus-Fischer-Str. 1, 72178 Waldachtal, Allemagne		
4. <u>Mandataire:</u>	-		
5. <u>Système(s) d'évaluation et de vérification de la constance des performances:</u>	1		
6. <u>Document d'évaluation européen:</u>	EAD 330232-01-0601, (Edition 12/ 2019)		
Evaluation Technique Européenne:	ETA-07/0211; 2020-07-13		
Organisme d'évaluation technique:	DIBt- Deutsches Institut für Bautechnik		
Organisme(s) notifié(s):	1343 MPA Darmstadt / 2873 TU Darmstadt		
7. <u>Performance(s) déclarée(s):</u>	Résistance mécanique et stabilité (BWR 1)		
Résistance caractéristique à la charge de traction (charge statique et quasi-statique):	Résistance à la rupture de l'acier:	Annexe C1	$E_s = 210\,000\text{ MPa}$
	Résistance à l'extraction glissement:	Annexe C1	
	Résistance à la rupture du cône béton:	Annexe C1	$k_{cr,N} = \text{NPD}$
	Robustesse:	Annexe C1	
	Distance au bord et entraxe mini.:	Annexe C3	
	Distance au bord pour éviter la rupture par fendage sous charge:	Annexe C1	
Résistance caractéristique à la charge de cisaillement (charge statique et quasi-statique), Méthode A:	Résistance à la rupture de l'acier (charge de cisailier)	Annexe C2	
	Résistance à la rupture par effet de levier :	Annexe C2	
Résistance caractéristique et déplacements pour les catégories de performance sismique C1 et C2:	Résistance à la charge de traction, déplacements, catégorie C1:	NPD	
	Résistance à la charge de traction, déplacements, catégorie C2:	NPD	
	Résistance à la charge de cisaillement, déplacements, catégorie C1:	NPD	
	Résistance à la charge de cisaillement, déplacements, catégorie C2:	NPD	
	Facteur espace annulaire :	NPD	
Résistance caractéristique pour un dimensionnement simplifié:	Méthode B:	NPD	
	Méthode C:	NPD	
Déplacements et Durabilité:	Déplacements sous charge statique et quasi-statique	Annexe C3	
	Durabilité:	Annexes A4, B1	
Sécurité en cas d'incendie (BWR 2)			
Réaction au feu:	Classe (A1)		
Résistance au feu:	Résistance en cas d'incendie, rupture de l'acier	NPD	
	Résistance en cas d'incendie, extraction glissement	NPD	
	Résistance en cas d'incendie, rupture de l'acier	NPD	



8. Documentation technique appropriée et/ou
documentation technique spécifique:

Les performances du produit identifié ci-dessus sont conformes aux performances déclarées. Conformément au règlement (UE) no 305/2011, la présente déclaration des performances est établie sous la seule responsabilité du fabricant mentionné ci-dessus.

Signé pour le fabricant et en son nom par:

Thilo Pregartner, Dr.-Ing.
Tumlingen, 2020-07-27

Peter Schillinger, Dipl.-Ing.

Cette DoP a été préparée en plusieurs langues. En cas de différend relatif à l'interprétation, la version anglaise prévaudra.

L'annexe comprend des informations volontaires et complémentaires en langue anglaise dépassant les exigences légales (spécifiées de manière neutre).

Specific Part

1 Technical description of the product

The fischer Bolt anchor FBN II and FBN II R is an anchor made of zinc plated, hot-dip galvanised or stainless steel which is placed into a drilled hole and anchored by torque-controlled expansion.

The product description is given in Annex A.

2 Specification of the intended use in accordance with the applicable European Assessment Document

The performances given in Section 3 are only valid if the fastener is used in compliance with the specifications and conditions given in Annex B.

The verifications and assessment methods on which this European Technical Assessment is based lead to the assumption of a working life of the fastener of at least 50 years. The indications given on the working life cannot be interpreted as a guarantee given by the producer, but are to be regarded only as a means for choosing the right products in relation to the expected economically reasonable working life of the works.

3 Performance of the product and references to the methods used for its assessment

3.1 Mechanical resistance and stability (BWR 1)

Essential characteristic	Performance
Characteristic resistance to tension load (static and quasi-static loading)	See Annex C 3, C 1
Characteristic resistance to shear load (static and quasi-static loading)	See Annex C 2
Displacements (static and quasi-static loading)	See Annex C 3
Characteristic resistance and displacements for seismic performance categories C1 and C2	No performance assessed
Durability	See Annex B 1

3.2 Safety in case of fire (BWR 2)

Essential characteristic	Performance
Reaction to fire	Class A1
Resistance to fire	No performance assessed

4 Assessment and verification of constancy of performance (AVCP) system applied, with reference to its legal base

In accordance with the European Assessment Document EAD 330232-01-0601 the applicable European legal act is: [96/582/EC].

The system to be applied is: 1

Cone bolt manufactured by cold - forming:

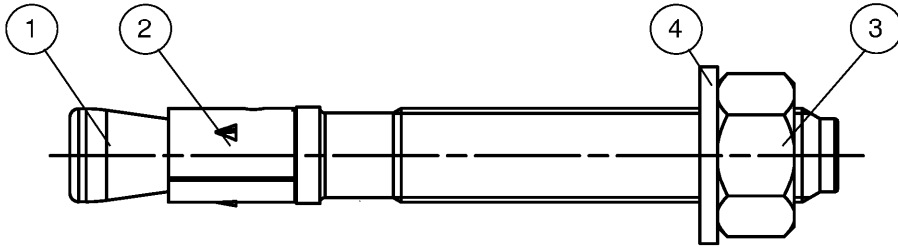

Cone bolt manufactured by turning:

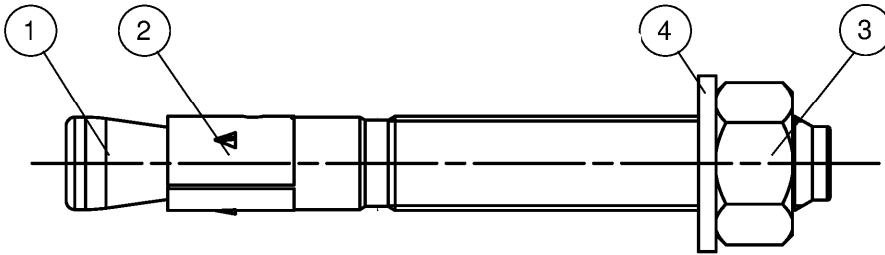

- ① Cone bolt (cold – formed or turned)
- ② Expansion sleeve
- ③ Hexagon nut
- ④ Washer

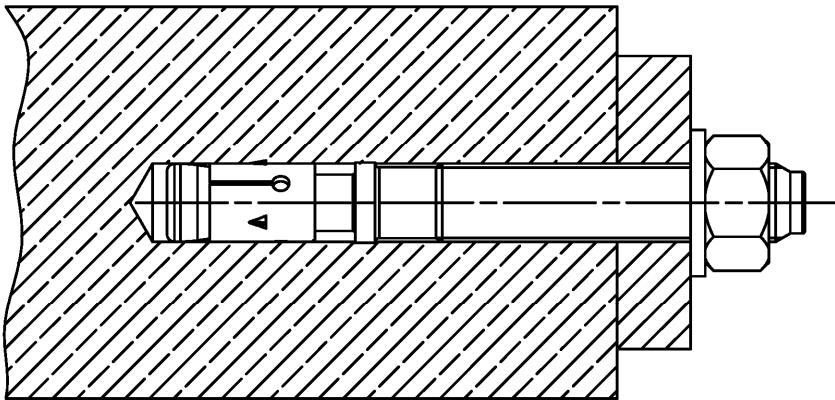

(Fig. not to scale)

fischer Bolt Anchor FBN II, FBN II R

Product description
Installed condition

Annex A 1

Appendix 2/ 11

FBN II for use with standard and reduced anchorage depth ($h_{ef, sta}$ and $h_{ef, red}$)

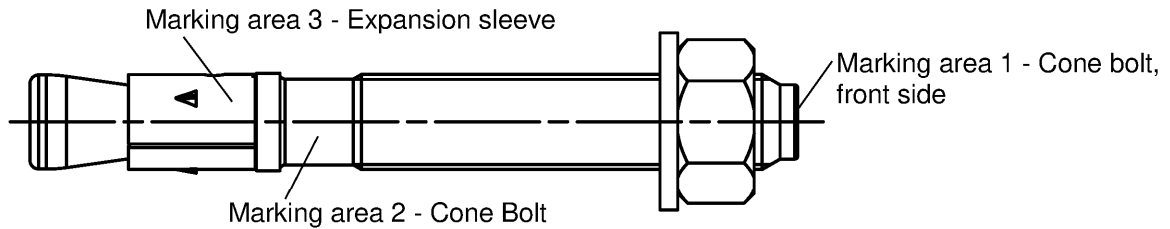

Product label, example:

FBN II 12/10 R

Brand | type of fastener
placed at marking area 2 or 3

Thread size / max. thickness of the fixture (t_{fix}) for $h_{ef, sta}$
identification R or HDG placed at marking area 2

Table A2.1: Letter-code on marking area 1 and maximum thickness of fixture t_{fix} [mm]:

marking		A	B	C	D	E	F	G	H	I	K	L	M	N	O	P	R	S	T	U	V	W	X	Y	Z
max. t_{fix} for $h_{ef, sta}$	M6-M20	5	10	15	20	25	30	35	40	45	50	60	70	80	90	100	120	140	160	180	200	250	300	350	400
max. t_{fix} for $h_{ef, red}$	M8, M10	15	20	25	30	35	40	45	50	55	60	70	80	90	100	110	130	150	170	190	210	260	310	360	410
	M12, M16	20	25	30	35	40	45	50	55	60	65	75	85	95	105	115	135	155	175	195	215	265	315	365	415
	M20	30	35	40	45	50	55	60	65	70	75	85	95	105	115	125	145	165	185	205	225	275	325	375	425

FBN II K for use with reduced anchorage depth only ($h_{ef, red}$):

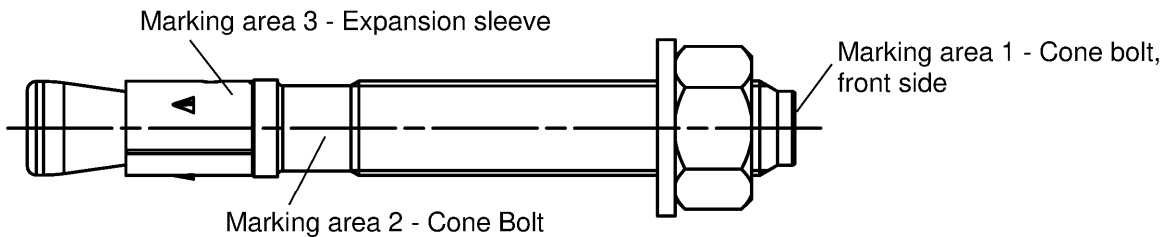

Product label, example:

FBN II 12/10 K R

Brand | type of fastener
placed at marking area 2 or 3

Thread size / max. thickness of the fixture (t_{fix})
identification K for $h_{ef, red}$
identification R or HDG placed on marking area 2

Table A2.2: Letter-code on marking area 1 and maximum thickness of fixture t_{fix} [mm]:

Markierung		-A-	-B-	-C-	-D-	-E-	-F-	-G-	-H-	-I-	-K-	-L-	-M-	-N-	-O-	-P-	-R-	-S-	-T-	-U-	-V-	-W-	-X-	-Y-	-Z-
max. t_{fix} for $h_{ef, red}$	M8-M20	5	10	15	20	25	30	35	40	45	50	60	70	80	90	100	120	140	160	180	200	250	300	350	400

Identification for $h_{ef, red}$ is the letter-code between 2 hyphen

(Fig. not to scale)

fischer Bolt Anchor FBN II, FBN II R

Product description
Product label and letter code

Annex A 2

Appendix 3/ 11

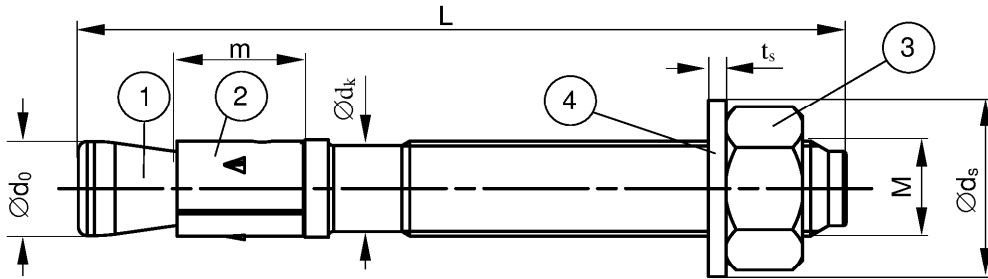

Table A3.1: Anchor dimensions [mm]

Part	Designation		FBN II, FBN II R					
			M6	M8	M10	M12	M16	M20
1	Cone bolt	M	M6	M8	M10	M12	M16	M20
		$\varnothing d_0$	5,9	7,9	9,9	11,9	15,9	19,6
		$\varnothing d_k$	5,2	7,1	8,9	10,8	14,5	18,2
2	Expansion sleeve	m	10	11,5	13,5	16,5	21,5	33,5
3	Hexagon nut	SW	10	13	17	19	24	30
4	Washer	t_s	1,0	1,4	1,8	2,3	2,7	2,7
		$\varnothing d_s$	11,5	15	19	23	29	36
Thickness of fixture		t_{fix}	0	0	0	0	0	0
			200	200	250	300	400	500
Length of fastener		L_{min}	45	56	71	86	120	139
		L_{max}	245	261	316	396	520	654

(Fig. not to scale)

fischer Bolt Anchor FBN II, FBN II R

Product description
Dimensions

Annex A 3

Appendix 4/ 11

Table A4.1: Materials FBN II (zinc plated $\geq 5\mu\text{m}$, ISO 4042:2018)

Part	Designation	Material
1	Cone bolt	Cold form steel or free cutting steel
2	Expansion sleeve	Cold strip, EN 10139:2016 ¹⁾
3	Hexagon nut	Steel, property class min. 8, EN ISO 898-2:2012
4	Washer	Cold strip, EN 10139:2013

¹⁾ Optional stainless steel EN 10088:2014

Table A4.2: Materials FBN II HDG (hot-dip galvanised $\geq 50\mu\text{m}$, ISO 10684: 2004 ²⁾)

Part	Designation	Material
1	Cone bolt	Cold form steel or free cutting steel
2	Expansion sleeve	Stainless steel EN 10088:2014
3	Hexagon nut	Steel, property class min. 8, EN ISO 898-2:2012
4	Washer	Cold strip, EN 10139:2016

¹⁾ Alternative method sherardized $\geq 50\mu\text{m}$, EN 13811:2003

Table A4.3: Materials FBN II R

Part	Designation	Material
1	Cone bolt	Stainless steel EN 10088:2014
2	Expansion sleeve	Stainless steel EN 10088:2014
3	Hexagon nut	Stainless steel EN 10088:2014 ISO 3506-2: 2009; property class min. 70
4	Washer	Stainless steel EN 10088:2014

fischer Bolt Anchor FBN II, FBN II R

Product description
Materials

Annex A 4

Appendix 5/ 11

Specifications of intended use

Anchorage subject to:

fischer Bolt Anchor FBN II, FBN II R		M6 ¹⁾	M8 ¹⁾	M10	M12	M16	M20
Material	Steel	Zinc plated			✓		
		Hot-dip galvanized HDG	-2)		✓		
	Stainless steel	R			✓		
Static and quasi-static loads					✓		
Reduced anchorage depth						✓	
Uncracked concrete					✓		

¹⁾ Use of FBN II 6 (gvz/R) and FBN II 8 (gvz/HDG/R) with $h_{ef} = 30\text{mm}$ restricted to anchoring of structural components which are statically indeterminate

²⁾ Anchor type not part of the assessment

Base materials:

- Reinforced or unreinforced normal concrete without fibres of strength classes C20/25 to C50/60 according to EN 206:2013+A1:2016

Use conditions (Environmental conditions):

- Structures subject to dry internal conditions:
- For all other conditions according to EN 1993-1-4:2015-10 corresponding to corrosion resistance class CRC III

FBN II, FBN II HDG

FBN II R

Design:

- Anchorage are to be designed under the responsibility of an engineer experienced in anchorages and concrete work
- Verifiable calculation notes and drawings are to be prepared taking account of the loads to be anchored. The position of the anchor is indicated on the design drawings (e.g. position of the anchor relative to reinforcement or to supports, etc.)
- Design of fastenings according to EN 1992-4:2018 and TR 055

fischer Bolt Anchor FBN II, FBN II R

Intended Use
Specifications

Annex B 1

Appendix 6/ 11

Table B2.1: Installation parameters

Type of anchor / size FBN II, FBN II R	M6	M8	M10	M12	M16	M20
Nominal drill hole diameter $d_0 =$	6	8	10	12	16	20
Cutting diameter of drill bit $d_{cut} \leq$	6,45	8,45	10,45	12,50	16,50	20,55
Standard anchorage depth $h_{ef,sta} =$	30 ¹⁾	40	50	65	80	105
Reduced anchorage depth $h_{ef,red} =$ [mm]	- ²⁾	30 ¹⁾	40	50	65	80
Standard drill hole depth $h_{1,sta} \geq$	40	56	68	85	104	135
Reduced drill hole depth $h_{1,red} \geq$	- ²⁾	46 ¹⁾	58	70	89	110
Diameter of clearance hole in the fixture $d_f \leq$	7	9	12	14	18	22
Required torque moment FBN II (zinc plated)	4	15	30	50	100	200
Required torque moment FBN II (hot-dip galvanized) $T_{inst} =$ [Nm]	- ³⁾	15	30	40	70	200
Required torque moment FBN II R	4	10	20	35	80	150

- 1) Use restricted to anchoring of structural components which are statically indeterminate
- 2) No performance assessed
- 3) Anchor type not part of the assessment

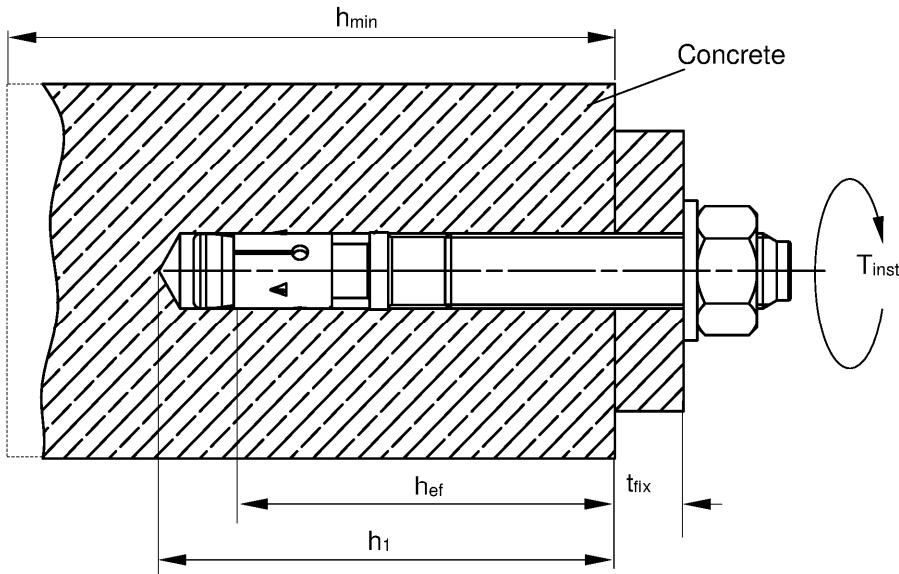

- h_{ef} = Effective embedment depth
- t_{fix} = Thickness of the fixture
- h_1 = Depth of drill hole to deepest point
- h_{min} = Minimum thickness of concrete member
- T_{inst} = Required setting torque

(Fig. not to scale)

fischer Bolt Anchor FBN II, FBN II R

Intended Use
Installation parameters

Annex B 2

Appendix 7/ 11

Installation instructions

- Fastener installation carried out by appropriately qualified personnel and under the supervision of the person responsible for technical matters of the site
- Use of the fastener only as supplied by the manufacturer without exchanging the components of the fastener
- Checking before placing the fastener to ensure that the strength class of the concrete in which the fastener is to be placed is in the range given and is not lower than that of the concrete to which the characteristic loads apply
- Check of concrete being well compacted, e.g. without significant voids
- Hammer or hollow drilling
- Drill hole created perpendicular $\pm 5^\circ$ to concrete surface, positioning without damaging the reinforcement
- In case of aborted hole: new drilling at a minimum distance twice the depth of the aborted drill hole or smaller distance if the aborted drill hole is filled with high strength mortar and if under shear or oblique tension load it is not in the direction of load application

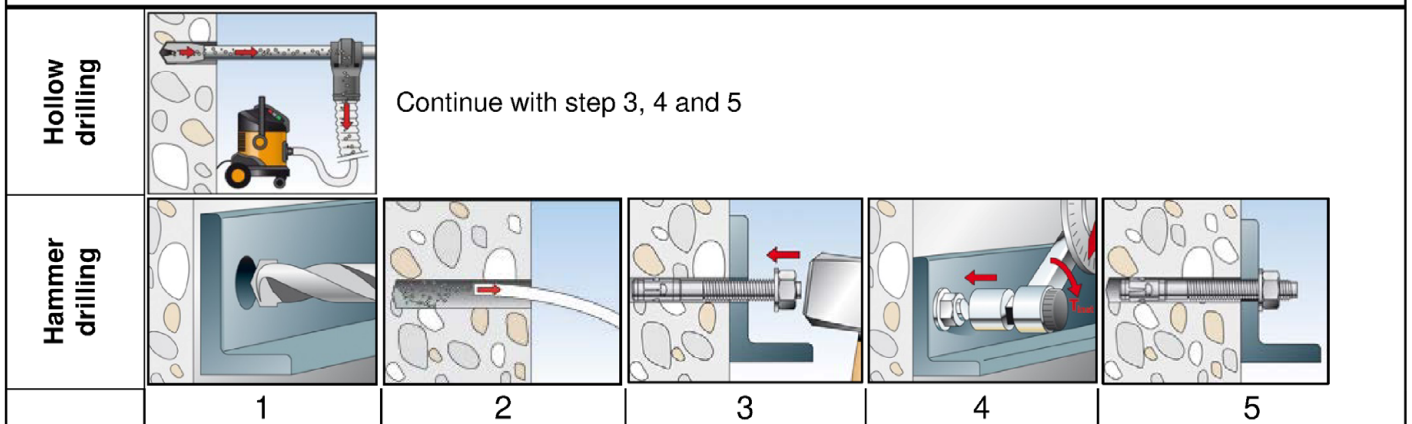

No.	Description	
1	Create drill hole with hammer drill	Create drill hole with hollow drill and vacuum cleaner
2	Clean drill hole	-
3	Set anchor	
4	Expand anchor with prescribed installation torque T_{inst}	
5	Finished installation	

Types of drills

Hammer drill



Hollow drill



fischer Bolt Anchor FBN II, FBN II R

Intended Use
Installation instructions

Annex B 3

Appendix 8/ 11

Table C1.1: Characteristic values of **tension** resistance under static and quasi-static action

Type of anchor / size			M6	M8	M10	M12	M16	M20
Steel failure for standard and reduced anchorage depth FBN II								
Characteristic resistance FBN II	$N_{Rk,s}$	[kN]	8,3	16,5	27,2	41,6	77,9	107
Partial factor	γ_{Ms}^1	[-]	1,5	1,4	1,4	1,4	1,5	1,5
Steel failure for standard and reduced anchorage depth FBN II R								
Characteristic resistance FBN II R	$N_{Rk,s}$	[kN]	10,6	16,5	27,2	41,6	78	111
Partial factor	γ_{Ms}^1	[-]	1,5	1,4	1,4	1,4	1,4	1,5
Pullout failure for standard anchorage depth FBN II, FBN II R								
Characteristic resistance C20/25	$N_{Rk,p}$	[kN]	6 ⁴⁾	12,5	17,4	25,8	35,2	52,9
Pullout failure for reduced anchorage depth FBN II, FBN II R								
Characteristic resistance C20/25	$N_{Rk,p}$	[kN]	-. ⁵⁾	6 ⁴⁾	12,5	17,4	25,8	35,2
Increasing factors for $N_{Rk,p}$	ψ_c	C25/30	1,12					
		C30/37	1,22					
		C35/45	1,32					
		C40/50	1,41					
		C45/55	1,50					
		C50/60	1,58					
Installation factor	γ_{inst}	[-]	1,0					
Concrete cone and splitting failure for standard anchorage depth FBN II, FBN II R								
Effective anchorage depth	$h_{ef, sta}$	[mm]	30 ⁴⁾	40	50	65	80	105
Factor for uncracked concrete	$k_{Ucr,N}$	[-]	11,0 ²⁾					
Spacing	$s_{cr,N}$	[mm]	3 $h_{ef, sta}$					
Edge distance	$c_{cr,N}$		1,5 $h_{ef, sta}$					
Spacing (splitting failure)	$s_{cr,sp}$		130 ⁴⁾	190	200	290	350	370
Edge distance (splitting failure)	$c_{cr,sp}$		65 ⁴⁾	95	100	145	175	185
Characteristic resistance to splitting	$N^0_{Rk,sp}$	[kN]	min { $N^0_{Rk,c}$, $N_{Rk,p}$ } ³⁾					
Concrete cone and splitting failure for reduced anchorage depth FBN II, FBN II R								
Effective anchorage depth	$h_{ef, red}$	[mm]	-. ⁵⁾	30 ⁴⁾	40	50	65	80
Factor for uncracked concrete	$k_{Ucr,N}$	[-]	11,0 ²⁾					
Spacing	$s_{cr,N}$	[mm]	3 $h_{ef, red}$					
Edge distance	$c_{cr,N}$		1,5 $h_{ef, red}$					
Spacing (splitting failure)	$s_{cr,sp}$		-. ⁵⁾	190 ⁴⁾	200	290	350	370
Edge distance (splitting failure)	$c_{cr,sp}$		-. ⁵⁾	95 ⁴⁾	100	145	175	185

¹⁾ In absence of other national regulations

²⁾ Based on concrete strength as cylinder strength

³⁾ $N^0_{Rk,c}$ according to EN 1992-4:2018

⁴⁾ Use restricted to anchoring of structural components which are statically indeterminate

⁵⁾ No performance assessed

fischer Bolt Anchor FBN II, FBN II R

Performances
Characteristic values of **tension** resistance

Annex C 1

Appendix 9/ 11

Table C2.1: Characteristic values of **shear** resistance under static and quasi-static action

Type of anchor / size	M6	M8	M10	M12	M16	M20	
Installation Factor γ_{inst} [-]	1,0						
Steel failure without lever arm for standard and reduced anchorage depth							
Characteristic resistance $V_{Rk,s}^0$ [kN]	FBN II	6,0 ²⁾	13,3	21,0	31,3	55,1	67
	FBN II R	5,3 ²⁾	12,8	20,3	27,4	51	86
Steel failure with lever arm for standard anchorage depth							
Characteristic bending moment $M_{Rk,s}^0$ [Nm]	FBN II	9,4 ²⁾	26,2	52,3	91,6	232,2	422
	FBN II R	8 ²⁾	26	52	85	216	454
Steel failure with lever arm for reduced anchorage depth							
Characteristic bending moment $M_{Rk,s}^0$ [Nm]	FBN II	- ³⁾	19,9 ²⁾	45,9	90,0	226,9	349
	FBN II R	- ³⁾	21 ²⁾	47	85	216	353
Partial factor steel failure γ_{Ms}^1 [-]	1,25						
Factor for ductility k_7 [-]	1,0						
Concrete pryout failure for standard anchorage depth FBN II, FBN II R							
Factor for pryout failure k_8 [-]	1,4	1,8	2,1	2,3	2,3	2,3	
Concrete pryout failure for reduced anchorage depth FBN II, FBN II R							
Factor for pryout failure k_8 [-]	- ³⁾	1,8	2,1	2,3	2,3	2,3	
Concrete edge failure for standard anchorage depth FBN II, FBN II R							
Effective length of anchor $l_{f,sta}$ [mm]	30 ²⁾	40	50	65	80	105	
Effective diameter of anchor d_{nom}	6	8	10	12	16	20	
Concrete edge failure for reduced anchorage depth FBN II, FBN II R							
Effective length of anchor $l_{f,red}$ [mm]	- ³⁾	30 ²⁾	40	50	65	80	
Effective diameter of anchor d_{nom}	- ³⁾	8	10	12	16	20	

¹⁾ In absence of other national regulations

²⁾ Use restricted to anchoring of structural components which are statically indeterminate

³⁾ No performance assessed

fischer Bolt Anchor FBN II, FBN II R

Performances
Characteristic values of **shear** resistance

Annex C 2

Appendix 10/ 11

Table C3.1: Minimum thickness of concrete members, minimum spacing and minimum edge distance

Type of anchor / size FBN II, FBN II R			M6	M8	M10	M12	M16	M20
Standard anchorage depth	Effective anchorage depth	$h_{ef, sta}$	30 ²⁾	40	50	65	80	105
	Minimum thickness of member	h_{min}	100	100	100	120	160	200
	Minimum spacing	s_{min} [mm]	40	40	50 (70 ¹⁾)	70	90 (120 ¹⁾)	120
	Minimum edge distance	c_{min}	40	40 (45 ¹⁾)	50 (55 ¹⁾)	70	90 (80 ¹⁾)	120
Reduced anchorage depth	Effective anchorage depth	$h_{ef, red}$	- ³⁾	30 ²⁾	40	50	65	80
	Minimum thickness of member	h_{min}	- ³⁾	100	100	100	120	160
	Minimum spacing	s_{min} [mm]	- ³⁾	40 (50 ¹⁾)	50	70	90	120 (140 ¹⁾)
	Minimum edge distance	c_{min}	- ³⁾	40 (45 ¹⁾)	80	100	120	120

¹⁾ Values for FBN II R

²⁾ Use restricted to anchoring of structural components which are statically indeterminate

³⁾ No performance assessed

Table C3.2: Displacements under static and quasi static **tension** loads

Type of anchor / size FBN II, FBN II R			M6	M8	M10	M12	M16	M20
Standard anchorage depth	$h_{ef, sta}$	[mm]	30	40	50	65	80	105
Tension load C20/25	N	[kN]	2,8	6,1	8,5	12,6	17,2	25,8
Displacements	δ_{N0}	[mm]	1,9	0,6	0,9	1,5 (1,9 ¹⁾)	1,8	1,8 (2,0 ¹⁾)
	$\delta_{N\infty}$		3,1 (2,7 ¹⁾)					
Reduced anchorage depth	$h_{ef, red}$		- ²⁾	30	40	50	65	80
Tension load C20/25	N	[kN]	- ²⁾	2,8	6,1	8,5	12,6	17,2
Displacements	δ_{N0}	[mm]		0,4	0,7	0,7	0,9	1,0
	$\delta_{N\infty}$		1,6 (1,7 ¹⁾)					

¹⁾ Values for FBN II R

²⁾ No performance assessed

Table C3.3: Displacements under static and quasi static **shear** loads

Type of anchor / size FBN II, FBN II R			M6	M8	M10	M12	M16	M20
Shear load FBN II	V	[kN]	3,4	7,6	12,0	17,9	31,5	38,2
Displacements FBN II	δ_{v0}	[mm]	0,7	1,5	1,6	2,0	3,0	2,6
	$\delta_{v\infty}$		1,1	2,3	2,4	3,0	4,5	3,9
Shear load FBN II R	V	[kN]	3,0	7,3	11,6	15,7	29,1	49,0
Displacements FBN II R	δ_{v0}	[mm]	1,5	1,4	2,1	2,6	2,7	4,6
	$\delta_{v\infty}$		2,3	2,2	3,2	3,9	4,1	7,0

fischer Bolt Anchor FBN II, FBN II R

Performances

Minimum thickness of concrete members, minimum spacing and minimum edge distance
Displacements due to tension and shear loads

Annex C 3

Appendix 11/ 11